

LL52-1032-ES

52" Energy Star Ceiling Fan with Pull Chain. Available in 7 Finishes.

Finishes:

- Brushed Nickel with Natural Maple Blades (BNMP)
- Brushed Nickel with Brushed Nickel Blades (BN)
- Brushed Nickel with Rosewood Blades (BNRW)
- Brushed Nickel with White Blades (BNWH)
- Brushed Nickel with Walnut Blades (BNW)
- Oil Rubbed Bronze with Walnut Blades (ORBW)
- White with White Blades (WH)

Dimensions: 52.00"OD 12.6"OH

Blades: 5 MDF Blades.

Notes/Certifications/Warranty:

- 120V
- 4" Downrod
- Lead Wire: 52"
- Installation: Dual Mount *(can be installed flush to ceiling or use included down rod)*
- Contact your Lumencia rep with the fan part number and slope angle if you are mounting to a sloped ceiling – we will let you know if this fan requires further accessories to accommodate
- Pull Chain Standard
- Remote Control *(Sold Separately Part# LLRC-10-AC)*
- Light Kit *(Sold Separately see Page 2)*
- Wall Control Adaptable *(Sold Separately Part# LLWC8-WH or LLWC16-WH)*
- AC Motor | 172 x14mm | 3 capacitors
- Speeds: 3, Reversible
- RPM: 197 (High)/79 (Low)
- CFM: 5017
- Airflow Efficiency: 101
- ETLus Listed for Dry Locations
- Energy Star Rated
- Limited Lifetime Motor Warranty
- All Other Parts Have a 1 Year Warranty.

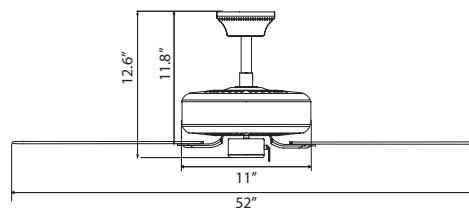

ORDERING INFORMATION

Model	Finish
LL52-1032-ES	BNMP BN BNRW BNWH BNW ORBW WH

LK82-MBLED-ES

Energy Star Rated Light Kit in 5 Finishes

Construction: Steel Frame

Lens: Satin Glass

Dimensions: 11.00"OD x 4.25"H

Finishes:

- Brushed Nickel (BN)
- Black (BLK)
- Matte Black (MBL)
- Oil Rubbed Bronze (ORB)
- White (WH)

Light Source: Includes 2 x 120V9w/1600lm/@30K/90CRI/Dimmable Medium Base LED A19 Lamps

Notes/Certifications/Warranty:

- 120V
- Pull Chain Standard
- TRIAC Dimmable: 10-100%
- cETLus Listed for Dry Locations
- Energy Star Listed
- 25K Life Hours
- 1 Year Limited Warranty



ORDERING INFORMATION

Part #	Finish
LK82-MBLED-ES	BN BLK MBL ORB WH

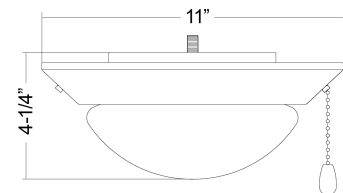

LLK18-ES-3X9W

Ceiling Fan Light Kit in 4 Finishes

Finishes:

- Brushed Nickel (BN)
- Oil Rubbed Bronze (ORB)
- White (WH)
- Black (BLK)

Construction:

- Durable Steel Base
- Satin Glass Lens

Dimensions: 12.00"OD x 6.75"H

Light Source (Included): 3x 120V/9w/800lm(Source) 30K/90CRI/TRIAC Dimmable Medium Based LED A19 Lamps

Notes/Certifications/Warranty:

- For Use with LL52-1032B-ES
- 120V
- Dimmable TRIAC, 10-100%
- Energy Star 4.0 Compliant
- cETLus listed
- 25K Life Hours
- 3 year limited warranty for Lamp
- 5 year limited warranty for light Kit.



ORDERING INFORMATION

Model	Finish
LLK18-ES-3X9W	BN ORB WH BLK

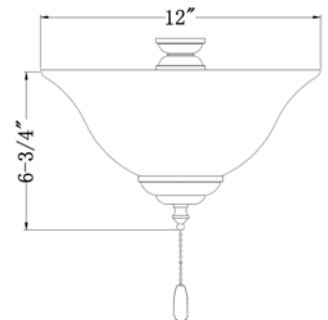

Job Name: _____

Type: _____

Part #: _____

Notes: _____

Downrods







LLDR 1/2" Downrod available in several sizes.

Features:

- 0.5" Diameter Downrod
- Available in 12", 18", 24", 36", and 48"
- Recommended 7' of clearance under ceiling fan blades



Part #	Finish
LLDR12	BN
LLDR18	BLK
LLDR24	WH
LLDR36	ORB
LLDR48	

Part #	Image	Speeds/ Light Control	Electrical Notes	Notes
LLRC-10-AC 3 Speed Hand-held remote control for AC motor ceiling fans		<ul style="list-style-type: none"> • 3-speed fan control - Hi, Med, Low, Off • Light control - On-Off, full-range dimming 	<ul style="list-style-type: none"> • 120V/ 60Hz • 3-wire installation • 1.5A Max Load for Ceiling Fan • 300W Max Load for Light • Compatible with LED, CFL and Incandescent Fans <p>Transmitter: Requires 9V Battery (not included)</p> <p>Receiver: 4-DIP Switches; 16 possible combination for multiple fan operation</p> <p>Not Suitable for Multi-Family Units</p>	<p>Dimensions: 4.5" L x 4.5" W x 0.87" W</p> <ul style="list-style-type: none"> • Canopy Wall Mount • White Finish • 3 Wire Installation • Use with CFL and LED Source • Maximum distance is 20 feet • UL Listed for Dry location applications • FCC Certified • 1 Year Limited Warranty 
LLWC8-WH 4 Speed Wall Control for Fans with Light Kits		<ul style="list-style-type: none"> • 4 Speed Fan Control • Full-range dimming of light 	<ul style="list-style-type: none"> • 120V/ 60Hz • 3-wire installation • Compatible with LED, CFL and Incandescent Fans 	<p>Dimensions: 1.75"W x 4.125"H1.75"W x 4.125"H</p> <ul style="list-style-type: none"> • Installs in a standard single-gang electrical box. • Wall Control must be Mounted Indoors • Not for Multiple Fan Control • cULus Listed for Dry Locations 
LLWC16-WH 3 Speed Wall Control for Fans with Light Kits		<ul style="list-style-type: none"> • 3 Speed Fan Control- Hi, Med, Low, Off • On/Off Light Control 	<ul style="list-style-type: none"> • 120V/ 60Hz • 3-wire installation • Compatible with LED, CFL and Incandescent Fans 	<p>Dimensions: 1.75"W x 4.125"H1.75"W x 4.125"H</p> <ul style="list-style-type: none"> • Installs in a standard single-gang electrical box. • Wall Control must be Mounted Indoors • Not for Multiple Fan Control • cULus Listed for Dry Locations 
LLWC13-WH 4 Speed Fan Control For Fan Only		<ul style="list-style-type: none"> • 4 Speed Fan Control 	<ul style="list-style-type: none"> • 120V/ 60Hz • Fan Load Max 1.25A Light Load Max 500W • Compatible with CFL Fans 	<p>Dimensions: 1.75" W x 4.125" H</p> <ul style="list-style-type: none"> • 3-wire installation • Installs in a standard single-gang electrical box. • Wall Control must be Mounted Indoors • Not for Multiple Fan Control • cULus Listed for Dry Locations 