

# DISCONTINUED 10/2024

## LLDLV

Dual Louvered Architectural Linear

**Housing:** Die formed 20 gauge cold-rolled steel housing. Flat steel end plate standard. (Die-cast aluminum spade end cap optional)  
**Finish:** White standard; other finishes by request  
**Reflector:** Die-formed white painted steel reflector standard.

**Distribution:** Up Light and Down Light

**Mounting:** Suspension Mounted. Includes aircraft cable.

### LED & Electrical:

- 82.8 CRI Standard
- L70: >54,000 hours
- Nominal Lamp Life: 100,000 hours.
- 0-10VDC dimming 1%~100%. (Std)
- High Power Factor: 120 ~ 277 Vac input range, 50 / 60 Hz.
- Class1 or Class 2 circuit.
- Operating Temperature: 4°F (-20°C) ~ 122°F (50°C).
- <ELCU-200> Option
  - Guarantees emergency lighting remains ON or is turned on when power to the control device is lost.
  - Interfaces with fire alarm panel or security system.

### Warranty/Certifications:

- 5 year limited warranty.
- cULus/UL listed for damp locations
- TITLE 24 Compliant.
- ARRA compliant. (optional)
- CEC Compliant EM (contact your Lumencia rep for more information)

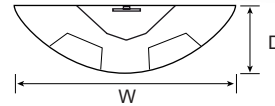

All dimensions are in inches (millimeters).

### Specifications: LLDLV 2', 3', 4'

Length: 24, 36, 48  
 (609 / 914 / 1220)  
 Width: 9 (229)  
 Depth: 3 (76)  
 Weight:  
 LLDLV: 16.09 lbs (7.3 kg)



[ Standard ]



[ SPE option ]

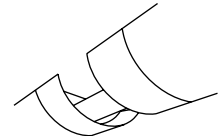

[ BSC option ]

### CONFIGURATIONS

|     | Model # | Input Watts | Lumen Output |
|-----|---------|-------------|--------------|
| 4FT | 46L     | 46W         | 3000 lm      |
|     | 60L     | 56.7W       | 3906 lm      |
|     | 72L     | 68.7W       | 4733 lm      |
|     | 81L     | 77.7W       | 5354 lm      |

| Zone   | Lumens | % of Luminaire |
|--------|--------|----------------|
| 0-40   | 183    | 3.4%           |
| 0-60   | 383    | 7.1%           |
| 0-90   | 683    | 12.8%          |
| 90-180 | 4672   | 87.2%          |

All dimensions are in inches (millimeters).

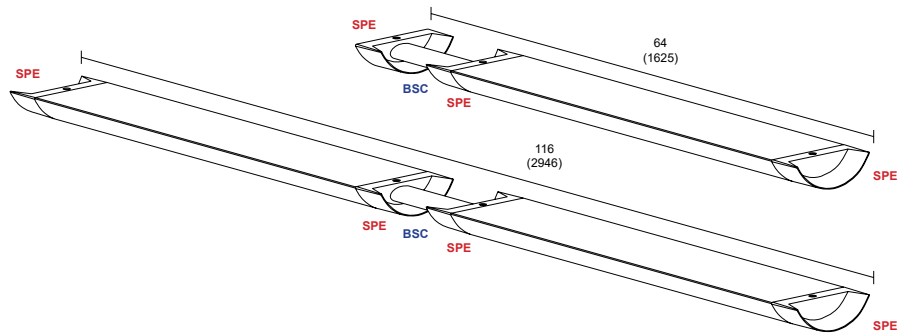
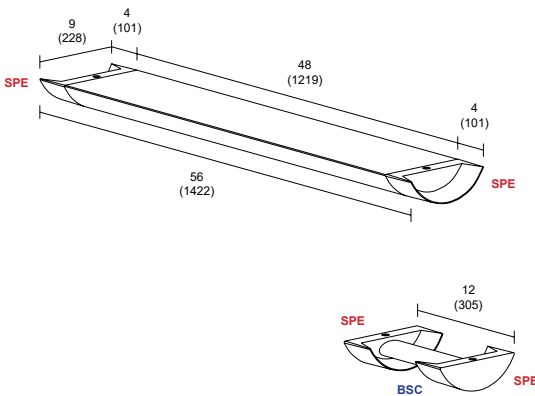

**Ordering Information**

| MODEL | LENGTH  | LED   | CCT                      | LOUVER  | TOP DIFFUSER  | VOLTAGE                  | DRIVERS   |
|-------|---|---|--------------------------|---|---|--------------------------|---|
| LLDLV | 2 2 Foot  | 976L 30W LED (976 lm/ft)<br>1183L 36W LED (1183 lm/ft)<br>1338L 40W LED (1338 lm/ft)<br>CLWP Custom Lumen-Wattage Package (We can offer a custom lumen ft or overall wattage package per your spec. Ask your Lumencia rep for more information)                             | 30K<br>35K<br>40K<br>50K | (Blank) Semi Specular (Std.)<br>WBL White Blade | (Blank) None<br>PA Prismatic Acrylic<br>CAClear Acrylic | UNV 120-277V<br>347 347V | (Blank) 0-10V dim to 1% (Std.) (dim both uplight and downlight simultaneously)<br>SD50 Bi-Level Step dim 50/100<br>TDM Triac Dim. (120V only)<br>ELV ELV compatible (reverse-phase or trailing-edge), (120V only)<br>PHSR Philips Xitanium Sensor-Ready, Dali 5%~100% dim.<br>PHDL Philips Xitanium DALI driver, Dim to 5%<br>DIMT Tri-mode dimming (Triac, ELV, 0-10V) |
|       | 3 3 Foot  | 976L 45W LED (976 lm/ft)<br>1183L 54W LED (1183 lm/ft)<br>1338L 60W LED (1338 lm/ft)<br>CLWP Custom Lumen-Wattage Package (We can offer a custom lumen ft or overall wattage package per your spec. Ask your Lumencia rep for more information)                             |                          |   |   |                          |   |
|       | 4 4 Foot  | 750L 46W LED (750 lm/ft)<br>976L 60W LED (976 lm/ft)<br>1383L 72W LED (1183 lm/ft)<br>1338L 81W LED (1338 lm/ft)<br>CLWP Custom Lumen-Wattage Package (We can offer a custom lumen ft or overall wattage package per your spec. Ask your Lumencia rep for more information) |                          |   |   |                          |   |
|       | XX Custom Length<br>(example 4x2 would be a 4' section times 2) | CLWP Custom Lumen-Wattage Package (We can offer a custom lumen ft or overall wattage package per your spec. Ask your Lumencia rep for more information)   |                          |   |   |                          |   |

| EM  | EM QTY   | OPTIONS   |
|---|--|---|
| (Blank) None (Std)<br>EM8 1296 LUMEN EM Battery Backup (CEC Compliant EM)<br>EM15 2430 LUMEN EM Battery Backup (CEC Compliant EM)<br>EM20 3240 LUMEN EM Battery Backup (CEC Compliant EM)<br>EM50 4050 LUMEN EM Battery Backup (CEC Compliant EM) | xSE Number of EMs<br><br><i>Em is per 4' run if you require more than 1 EM in a fixture 4' or longer, note qty and send a drawing broken out in 4' sections noting where EM is to be installed.</i><br><br><i>*Order with code COC for Separated EM feed for City of Chicago code compliance</i> | ELCU-200 Fail-to-on Emergency lighting, L924<br>OP Optional White Overlay on Louver<br>ARRA ARRA Compliant<br>BSC Straight Connector<br>AMS Occupancy Sensor w/ Daylight Harvesting<br>DPMS Daylight Dimming Photo Sensor (0-10 VDC Control),(LSR-301-S required)<br>SO Dimming Wires connected to Sensor Only<br>LSR-301-S Setup Remote Control for DPMS (Required for DPMS)<br>LSR-301-P Occupant Remote Control for DPMS<br>7W Optional 7 Years Limited Warranty 5<br>10W Optional 10 Years Limited Warranty 5 |

| FINISH<br><small>Std is White Fixture, White Cord, White Canopy</small> | FIXTURE  | Pendant Configuration | CEILING TYPE  | SUSPENSION   | CORD/CANOPY   |
|---|--|-----------------------|---|--|---|
|   | WH Matte White RAL#9003 (Std)<br>*SL Silver RAL#9022<br>*BLK Black RAL#9011<br>**AMC Anti-Microbial Coating (Matte White)<br>**RAL# Custom Color<br><small>*Additional Charge.<br/>**Additional charge &amp; set up fee.</small> |                       | T15 T-bar 15/16"<br>T9 T-bar 9/16"<br>HC Hard Ceiling<br>HS Hard Sloped Ceiling | AC4 4' Adjustable Aircraft Cable<br>AC8 8' Adjustable Aircraft Cable<br>CC Custom Length<br><i>1 Pair (2 aircraft cables) standard for up to 8' Length</i> | (Blank) White Cord/White Canopy<br>BLK- Black Cord/Black Canopy<br>CC- Custom Configuration<br><small>*Contact Us for more info, additional Charges and Set Up Fees Apply</small> |

**Compatible Dimmers:**

Standard 0-10 Dim, 1% Dims Both Simultaneously (Std.): Lumencia recommends Lutron Mark VII Dimmers and Leviton IP710-DLZ.

All others: Contact your Lumencia Rep for compatibility.

**Controls:**

Ask your Lumencia rep about compatibility with your control system

## PHOTOMETRIC DATA:

### LLDLV-2-30W-UNV

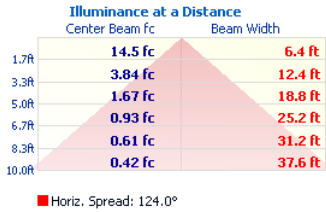

### LLDLV-2-36W-UNV

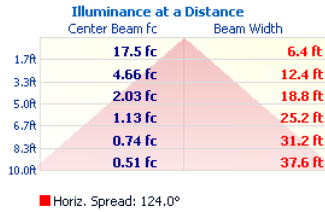

### LLDLV-2-40W-UNV

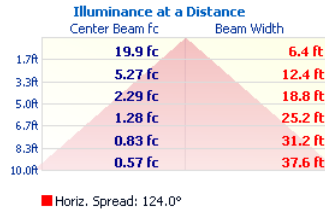

### LLDLV-3-45W-UNV

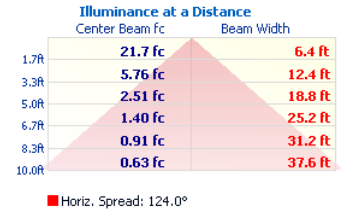

### LLDLV-3-54W-UNV

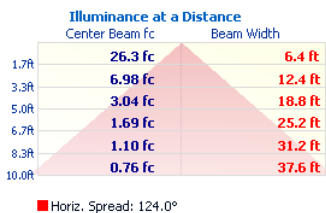

### LLDLV-3-60W-UNV

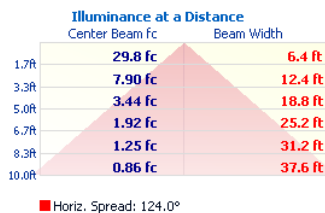

### LLDLV-4-46W-UNV

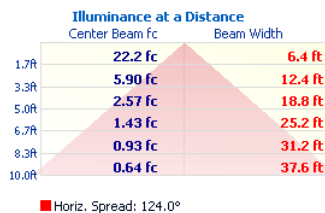

### LLDLV-4-60W-UNV

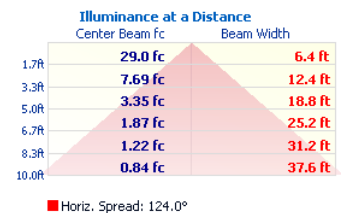

### LLDLV-4-72W-UNV

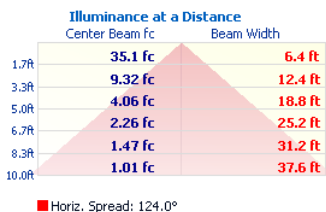

### LLDLV-4-81W-UNV

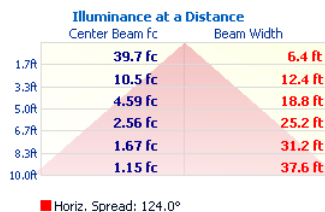

### Polar Candela Distribution

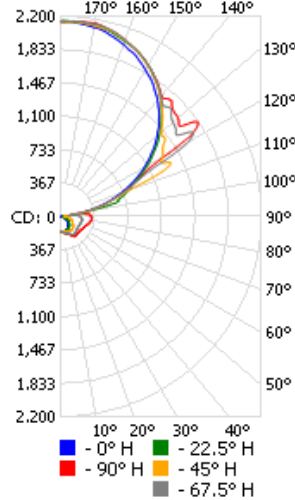

|                     |              |
|---------------------|--------------|
| Street Side (Down)  | 6.4%         |
| House Side (Down)   | 6.4%         |
| <b>Total (Down)</b> | <b>12.8%</b> |
| Street Side (Up)    | 43.6%        |
| House Side (Up)     | 43.6%        |
| <b>Total (Up)</b>   | <b>87.2%</b> |
| <b>Total</b>        | <b>100%</b>  |

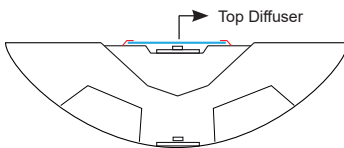

[ Top Diffuser Drawing ]

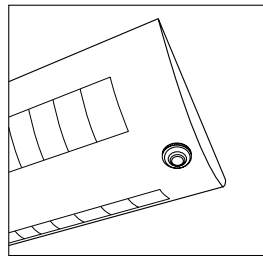

MS - Integrated Occupancy Sensor with Hold-Off Daylighting

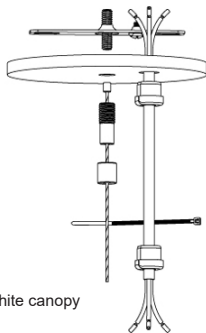

5" white canopy

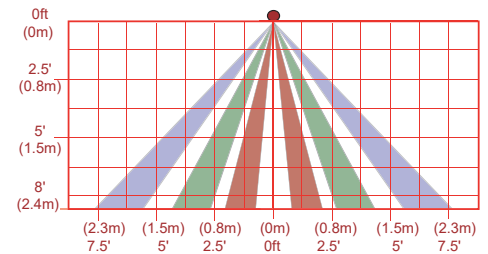

\* The coverage shown in the diagram is maximum. AMS is designed to detect small motion when mounted within 6' occupants.