

LLPARC Post Top

LED Area Light with 7 Wattages available

Construction:

- Die cast aluminum in Bronze. Custom Colors Available
- Mounts to 3" Dia. pole. 2-3/8" Mount by Special Order
- **LLPARC:** 14.55lbs (6.6kg)
- **LLPARCL:** 19.4lbs (8.8kg)
- EPA: 0.8925 sqft

Performance:

- Input Voltage: 120V-277V, 50/60Hz
- **LLPARC:** Choice of 30, 45, or 60 Watt LED
- **LLPARCL:** Choice of 70, 100, or 120 Watt LED
- Color Temperature: 30/40/50 (K)
- CRI: >70
- 120° distribution.
- LED Module: High efficiency up to 120 lm/W.
- Ambient Operating Temperature: -40°F (-40°C) ~ 113°F (45°C).
- Power Factor: >0.95

Notes

- cETLus Listed. Wet location.
- DLC pending.
- LM79, LM80 available.
- 5 year warranty.
- ARRA Compliant (Optional)
- L70 >50,000 hours

Controls/Options

See Ordering Section for Complete List

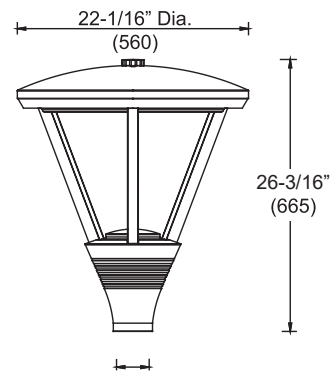

3"(76) Dia.
(3" pole is std.)

* All dimensions are in inches (millimeters).

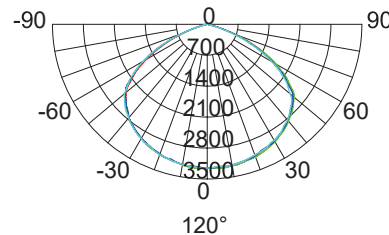

MODEL	LED	COLOR TEMP.	VOLTAGE	FINISH	MOUNTING
LLPARC	30- 30W/2910lm	-30K	UNV 120-277V (Std.)	BZ Bronze (RAL#8019) (Std.)	P3: 3" Pole
	45- 45W/423lm				
LLPARCL	60- 60W/5460lm	-40K	HV 347-480V	CC Custom Color * Available custom color (RAL) Please provide us with the RAL number. * Non-standard finish with extra charge.	P2: 2-3/8" Pole ¹
	70- 70W/8400lm	-50K			
	100-100W/12000lm 120-120W/14400lm				

Job Name: _____

Type: _____

Part #: _____

Notes: _____

CONTROL	SHIPPING OPTION	OPTIONS
(Blank) None DM 1-10V PCUNV Photocell - Button Type 120/277V MDS Motion/Daylight Sensor (Hi/ Low/ Off)	(Blank) Unassembled AS Assembled * Due to product's characteristic, we recommend and offer unassembled shipping as standard for damage prevention.	BIRD Bird Guard, Stainless Steel Spikes BU EM Battery Backup RC7 NEMA 7-wire receptacle only (no controls) ARRA ARRA compliant. (optional)

NOTES:
1. Longer lead time, please contact us for more information.

LLPARC-30

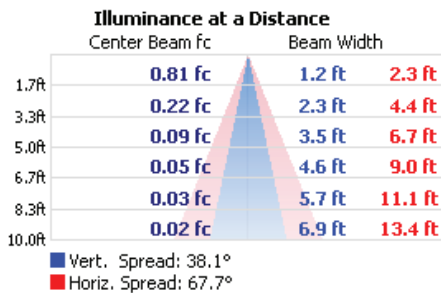

LLPARC-45

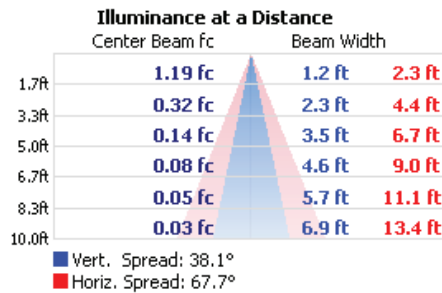

LLPARC-60

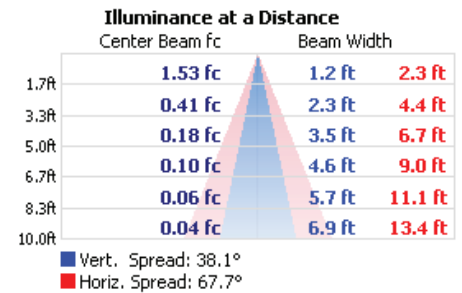

LLPARCL-70

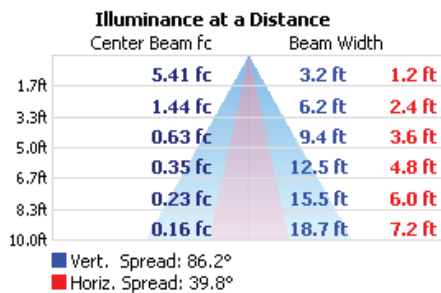

LLPARCL-100

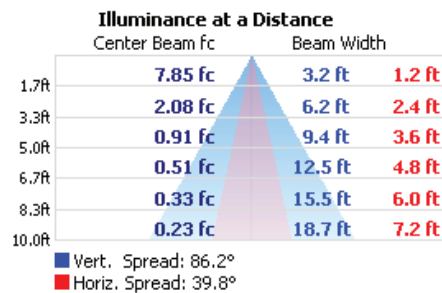

LLPARCL-120

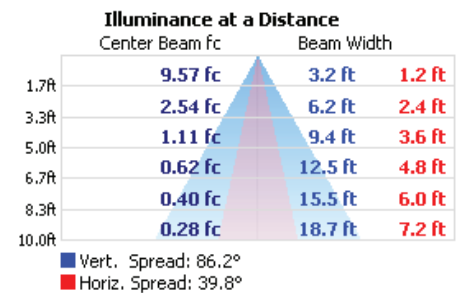

Optional MDS Sensor- Default Settings	
Detection Sensitivity	100%
Hold Time	90s
Day Light Sensor	Disable or 50lux
Stand by Time	10min
Stand by Dimming Level	10%