

# DISCONTINUED

## LLPBEL

Flared Arm Area Light in 7 Wattages

### Construction:

- Die cast aluminum housing in Bronze.
- Mounts to 3" Dia. pole. *2-3/8" Mount by Special Order*
- **LLPBEL**: 14.77lbs (6.7kg)
- **LLPBEL-L**: 17.64 (8kg)
- EPA: 0.8925 sqft

### Performance:

- Input Voltage: 120V-277V, 50/60Hz
- **LLPBEL**: Choice of 30, 40, 45, or 60 Watt LED
- **LLPBEL-L**: 17.64 (8kg)
- Color Temperature: 30/40/50 (K)
- CRI: >70
- 120° distribution
- Ambient Operating Temperature: -4°F (-20°C) ~ 113°F (45°C).

### Notes

- cETLus Listed, wet location.
- DLC Listed.
- LM79, LM80 available.
- 5 years warranty.
- L70 >50,000 hours

### Controls/Options

See Ordering Section for Complete List

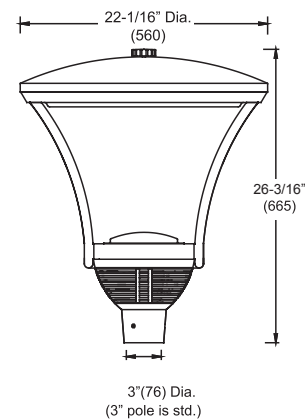

\* All dimensions are in inches (millimeters).

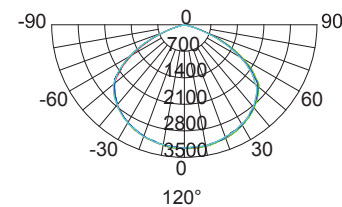

MODEL	LED	COLOR TEMP.	VOLTAGE	FINISH	MOUNTING
LLPBEL	30- 30W/2970lm	-30K	UNV 120-277V (Std.)	BZ Bronze (RAL#8019) (Std.)	P3 3" Pole
	40- 40W/3800lm <sup>3</sup>				
	45- 45W/4275lm				
LLPBEL-L	60- 60W/5580lm	-40K	HV 347-480V	CC Custom Color * Available custom color (RAL) Please provide us with the RAL number. * Non-standard finish with extra charge.	P2 2-3/8" Pole <sup>1</sup>
	70- 70W/6930lm	-50K			
	100-100W/9900lm				
	120-120W/11880lm				

CONTROL	SHIPPING OPTION	OPTIONS
<b>(Blank)</b> None <b>DM</b> 1-10V <sup>2</sup> <b>PCUNV</b> Photocell - Button Type 120/277V <b>MDS</b> Motion/Daylight Sensor (Hi/ Low/ Off)	<b>(Blank)</b> Unassembled  <b>AS</b> Assembled * Due to product's characteristic, we recommend and offer unassembled shipping as standard for damage prevention.	<b>BIRD</b> Bird Guard, Stainless Steel Spikes <b>BU</b> EM Battery Backup <b>RC7</b> NEMA 7-wire receptacle only (no controls) <b>ARRA</b> ARRA compliant. (optional)

NOTES:  
 1. Longer lead time, please contact us for more information.  
 2. Only available with 40W or higher wattage options.  
 3. Only available with DM option.

**LLPBEL-30**

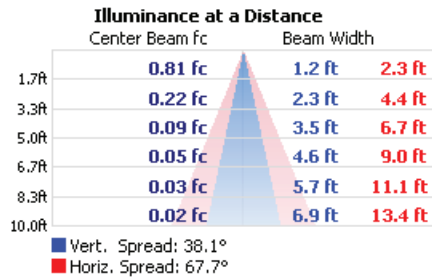

**LLPBEL-45**

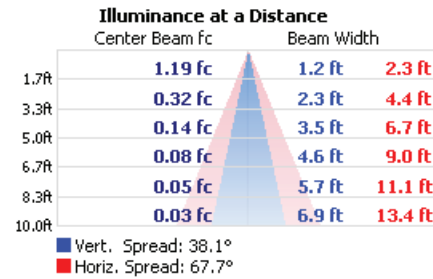

**LLPBEL-60**

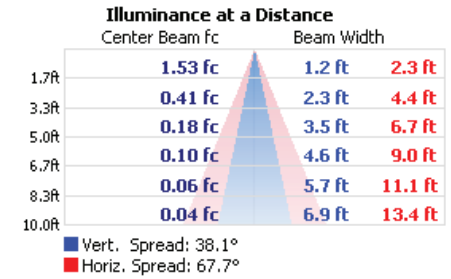

**LLPBEL-L-70**

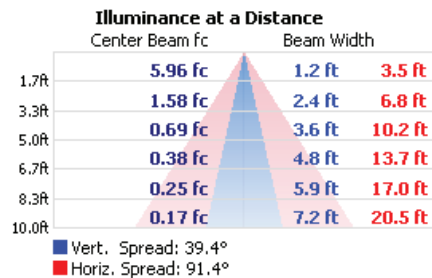

**LLPBEL-L-100**

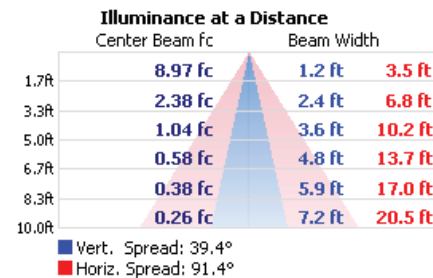

**LLPBEL-L-120**

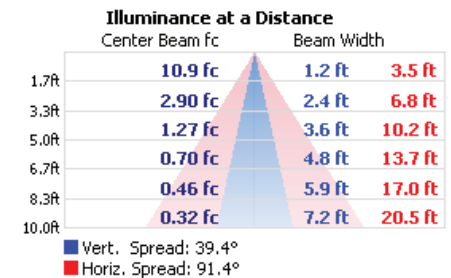

Optional MDS Sensor- Default Settings	
Detection Sensitivity	100%
Hold Time	90s
Day Light Sensor	Disable or 50lux
Stand by Time	10min
Stand by Dimming Level	10%